

**WARRANTY:** CK Worldwide, Inc. warrants products manufactured by CK Worldwide, Inc. to be free of defects in materials and workmanship. CK Worldwide, Inc. limits this warranty to replacement of the product or parts thereof and excludes liability for injury, property damage or economic loss attributable to product use or misuse. In any event, CK Worldwide, Inc. will only be responsible for its products when used with accessory items manufactured by CK Worldwide, Inc.

**INSTALLATION:** Before using this torch, - tighten regulator, hose and power cable fittings with proper wrenches. Using small pliers, securely tighten all knurled hose fittings (Slide the torch handle back for access to the torch connections). Purge the regulator and TIG torch with inert gas at 20 cubic feet per hour. Following these steps will ensure contamination free welds. Repeat this procedure whenever torch or regulator fittings have been detached.

**CONNECTION DIAGRAM:**

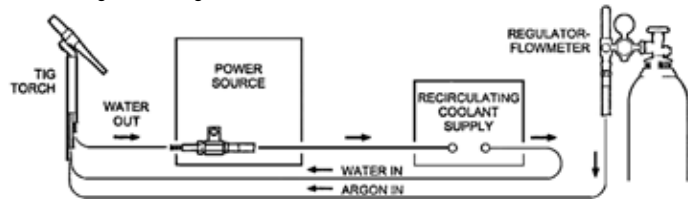

**INFORMATION CHART:**

Electrode Diameter in inches (mm)	Cup Size	WELDING CURRENT (AMPS) - TUNGSTEN TYPE				ARGON FLOW - FERROUS METALS		ARGON FLOW - ALUMINUM	
		AC Pure	AC Thoriated	DCSP Pure	DCSP Thoriated	Standard Body (Liters)	Gas Lens Body (Liters)	Standard Body (Liters)	Gas Lens Body (Liters)
.020 (0.50)	4 or 5	5 - 15	5 - 20	5 - 15	5 - 20	5-8 (3-4)	5-8 (3-4)	5-8 (3-4)	5-8 (3-4)
.040 (1.00)	4 or 5	10 - 60	15-80	15 - 70	20 - 80	5-10 (3-5)	5-8 (3-4)	5-12 (3-6)	5-10 (3-5)
1/16 (1.60)	4, 5 or 6	50 - 100	70 - 150	70 - 130	80 - 150	7-12 (4-6)	5-10 (3-5)	8-15 (4-7)	7-12 (4-6)
3/32 (2.40)	6, 7 or 8	100 - 160	140 - 235	150 - 220	150 - 250	10-15 (5-7)	8-10 (4-5)	10-20 (5-10)	10-15 (5-7)
1/8 (3.20)	7, 8 or 10	150 - 210	220 - 325	220 - 330	240 - 350	10-18 (5-9)	8-12 (4-6)	12-25 (6-12)	10-20 (5-10)
5/32 (4.00)	8 or 10	200 - 275	300 - 425	375 - 475	400 - 500	15-25 (7-12)	10-15 (5-7)	15-30 (7-14)	12-25 (6-12)
3/16 (4.80)	8 or 10	250 - 350	400 - 525	475-800	475-800	20-35 (10-17)	12-25 (6-12)	25-40 (12-19)	15-30 (7-14)
1/4 (6.40)	10	325 - 700	500 - 700	750 - 1000	700 - 1100	25-50 (12-24)	20-35 (10-17)	30-55 (14-26)	25-45 (12-21)

**TUNGSTEN PREPARATION:**

**END PREPARATION: DCSP (EN)**  
General Purpose:

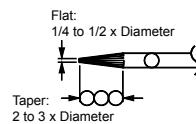

**ACHF**  
General Purpose:

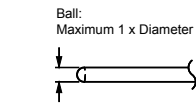

Ball tip by arcing on clean metal at low current DCRP (EP) then slowly increase current to form the desired ball diameter.

**GRINDING PREPARATION:**

Use a 60 Grit or finer aluminum oxide wheel

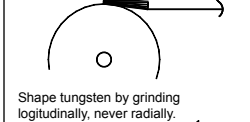

Shape tungsten by grinding longitudinally, never radially.



Remove sharp point to leave a truncated point with a flat spot. Diameter of flat spot determines amperage.



The included angle determines weld bead shape and size. Generally, as the included angle increases, penetration increases and bead width decreases.

**EXTENSION INSTRUCTION:**

**STANDARD PARTS**  
General Purpose:

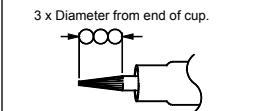

**GAS LENS PARTS**  
General Purpose:

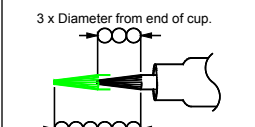

Maximum extension: 6 x Diameter from end of cup. (In draft - free areas)

**CAUTION:** Personal harm will result from touching the hot parts of a TIG torch without insulative protection, or from looking directly or indirectly at an arc or reflected arc. At no time should bare skin be exposed to a welding arc.



TIG TORCH MANUAL



CK20P

TECHNICAL INFORMATION

RATING @ 100% DUTY CYCLE: 250 AMP ACHF OR DCSP  
COOLING METHOD: WATER COOLED

ACCESSORY ITEMS REQUIRED FOR COMPLETE INSTALLATION:

HEAD ACCESSORIES: 2 SERIES HEAD ACCESSORIES  
POWER CABLE ADAPTOR: 45V11 (2PCA)

MODEL SELECTOR - TORCH PACKAGES

Head Style	Cable Style	Cable Length	Standard Cable	Superflex Cable
Rigid Head w/o valve	3 Piece Cables	12-1/2 ft. (3.8m)	CK20P-12	CK20P-12SF
		25 ft. (7.6m)	CK20P-25	CK20P-25SF

**IMPORTANT !!**  
**READ AND UNDERSTAND THE INFORMATION CONTAINED IN THIS MANUAL BEFORE OPERATING THE EQUIPMENT !**

PARTS:

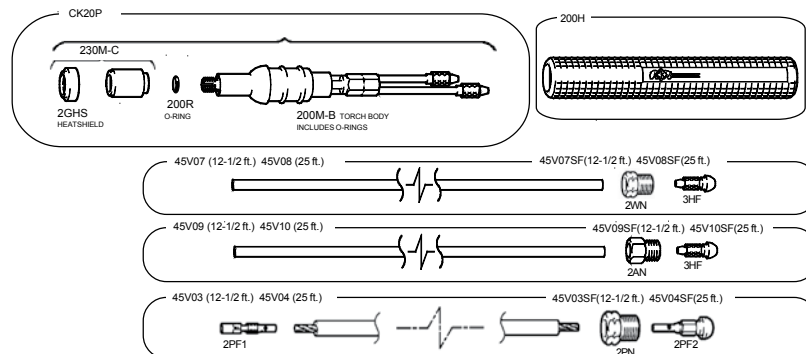

PARTS LIST:

PART NUMBER	DESCRIPTION	PART NUMBER	DESCRIPTION
CK20P	Torch Body, Rigid, 180 degree, 250 Amp	45V11(2PCA)	POWER CABLE ADAPTER
200H	Handle	SLWHAT-T	TWECO SAFE-LOC
45V07	Water Hose, 12-1/2 FT.	SLWHAT-25	DINSE-25 SAFE-LOC
45V08	Water Hose, 25 FT.	SLWHAT-35	DINSE-35 SAFE-LOC
45V07SF	Water Hose, Super Flex, 12-1/2 FT.	SLWHAT-25M	DINSE 25 FLOW-THRU GAS - SAFE-LOC
45V08SF	Water Hose, Super Flex, 25 FT.	SLWHAT-35M	DINSE 35 FLOW-THRU GAS - SAFE-LOC
45V03	Power Cable, Hi-Flex, 12-1/2 FT.	3HF	ARGON NUT
45V03SF	Power Cable, Super Flex, 12-1/2 FT.	2AN	HOSE FITTING
45V09	Gas Hose, Hi-Flex, 12-1/2 FT.	2PF1	POWER CABLE FITTING AND NUT
45V09SF	Gas Hose, Super Flex, 12-1/2 FT.	2PF2	POWER CABLE FITTING
45V04	Power Cable, Hi-Performance, 25 FT.		
45V04SF	Power Cable, Super Flex, 25 FT.		
45V10	Gas Hose, Hi-Performance, 25 FT.		
45V10SF	Gas Hose, Super Flex, 25 FT.		
200R	O-Ring		
2GH5	Heatshield, Standard		
230M-C	Collet Tightener for 200M-B		
200M-B	Torch Body, Includes O-Rings		

ACCESSORIES:

2 SERIES HEAD ACCESSORIES GAS SAVER

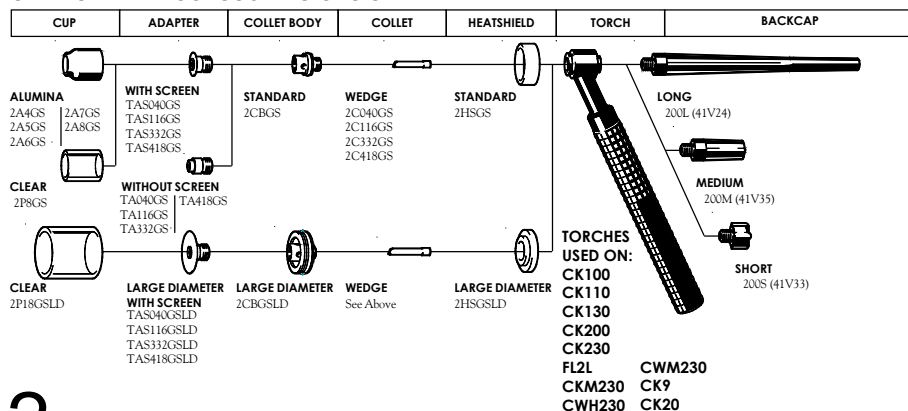

2

2 SERIES HEAD ACCESSORIES

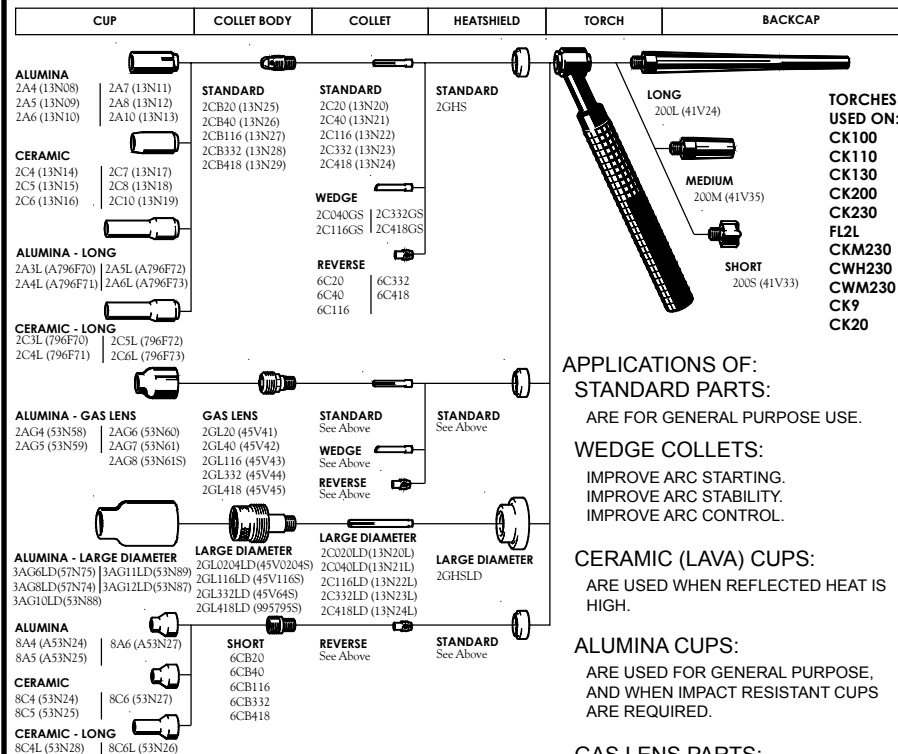

APPLICATIONS OF: STANDARD PARTS:

ARE FOR GENERAL PURPOSE USE.

WEDGE COLLETS:

IMPROVE ARC STARTING.  
IMPROVE ARC STABILITY.  
IMPROVE ARC CONTROL.

CERAMIC (LAVA) CUPS:

ARE USED WHEN REFLECTED HEAT IS HIGH.

ALUMINA CUPS:

ARE USED FOR GENERAL PURPOSE,  
AND WHEN IMPACT RESISTANT CUPS  
ARE REQUIRED.

GAS LENS PARTS:

ARE USED TO REDUCE TURBULENCE  
AND IMPROVE SHIELD GAS COVERAGE  
PATTERNS,  
INCREASES DUTY CYCLE OF TORCH  
AND INCREASES TUNGSTEN STICK  
OUT.

SHORT (STUBBY) PARTS:

ARE USED TO SHORTEN THE OVERALL  
LENGTH OF THE TORCH HEAD.  
REDUCES DUTY CYCLE OF TORCH

GAS SAVER® PARTS:

ARE USED TO SAVE UP TO 40% ON GAS  
CONSUMPTION.  
ARE USED TO SAVE UP TO 60% ON  
CONSUMABLE PARTS.  
ARE USED TO CLEARLY SEE THE WELD  
PUDDLE.  
ARE USED TO ACHIEVE GAS LENS

TUNGSTEN ELECTRODE CONVERSION CHART

Size Suffix	Inches	Millimeters
020	.020"	.5mm
040	.040"	1.0mm
116	1/16"	1.6mm
332	3/32"	2.4mm
418	1/8"	3.2mm
532	5/32"	4.0mm

3